

Further Development of Multi-Instrument Multi-Parameter Cloud Retrievals

Richard Austin, Norm Wood, and Graeme Stephens

Colorado State University, Fort Collins, Colorado

1. The Problem

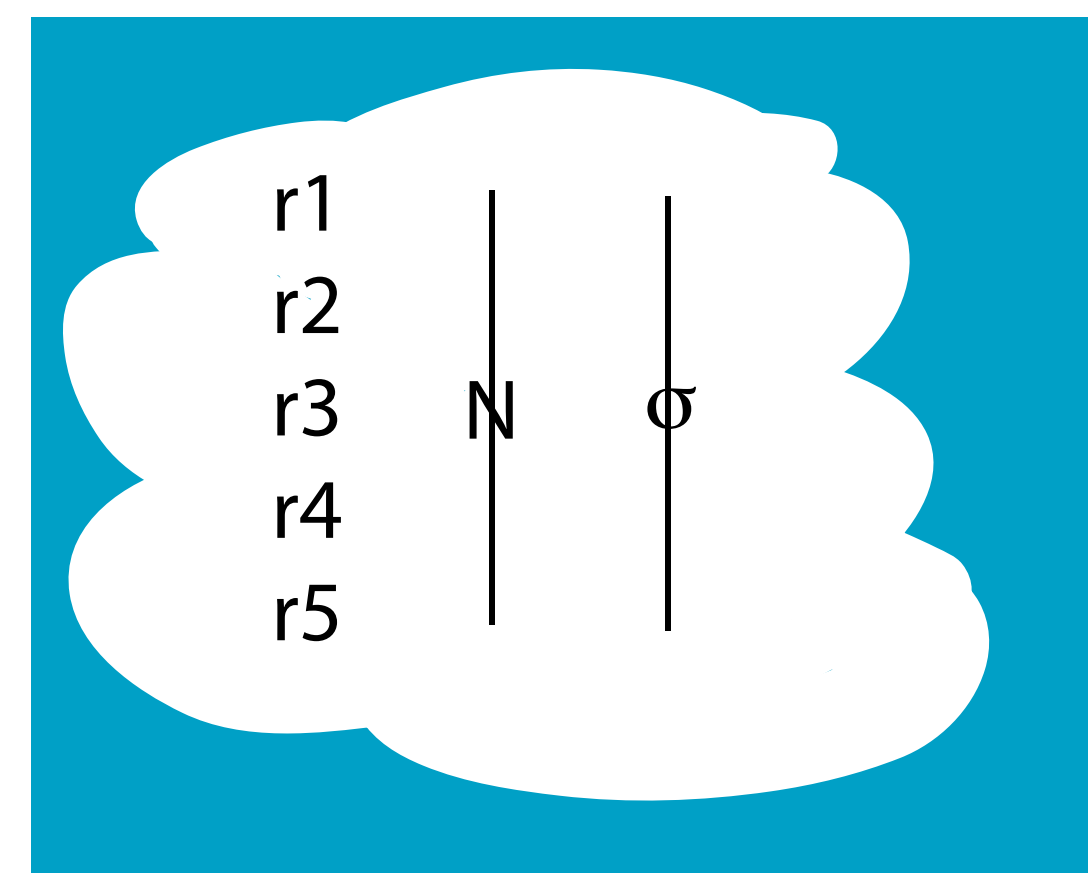

Former versions of our liquid and ice cloud microphysical retrievals were constrained to have two of the three distribution parameters constant with altitude. This precluded more sophisticated retrieval schemes.

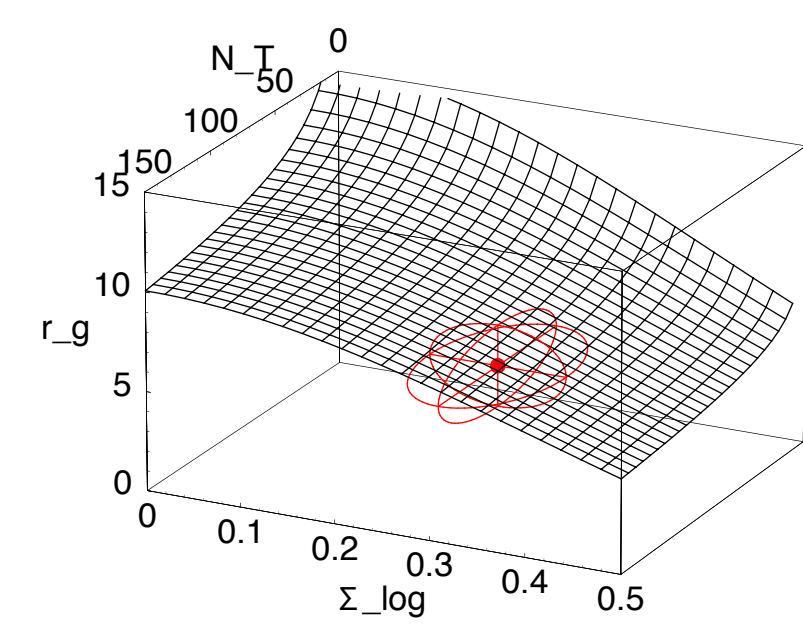

Solution surface for a single cloud bin, radar-only solution, for a given reflectivity level.

2. Approach

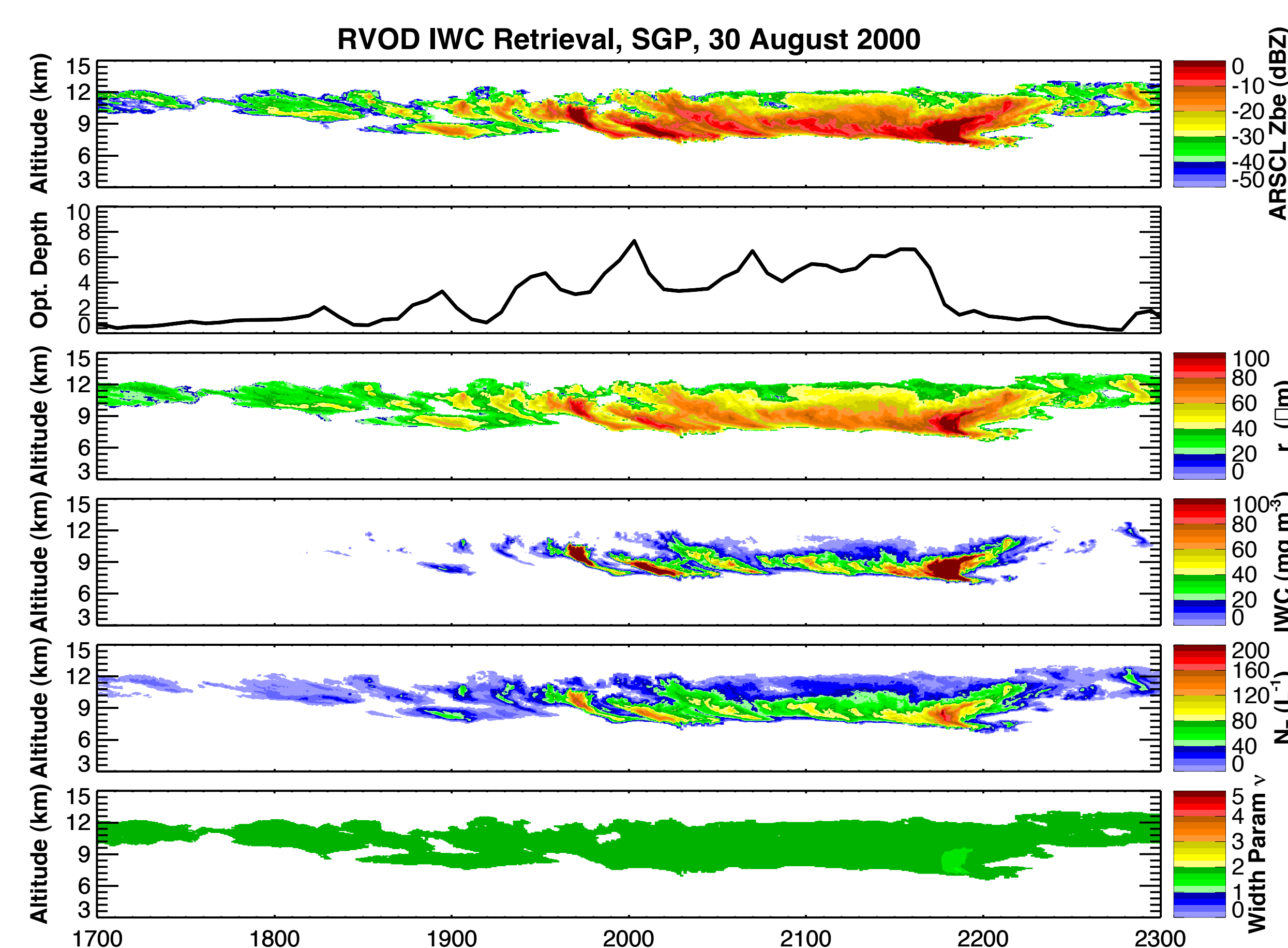

The new retrieval allows all three parameters to vary with height. While these parameters may still be primarily determined by a priori data (depending on the number of measurements), the additional degrees of freedom allow better fits to the measurement data and use of variable a priori information. The above case is an ice cloud retrieval using radar and visible optical depth as inputs.

3. Effects

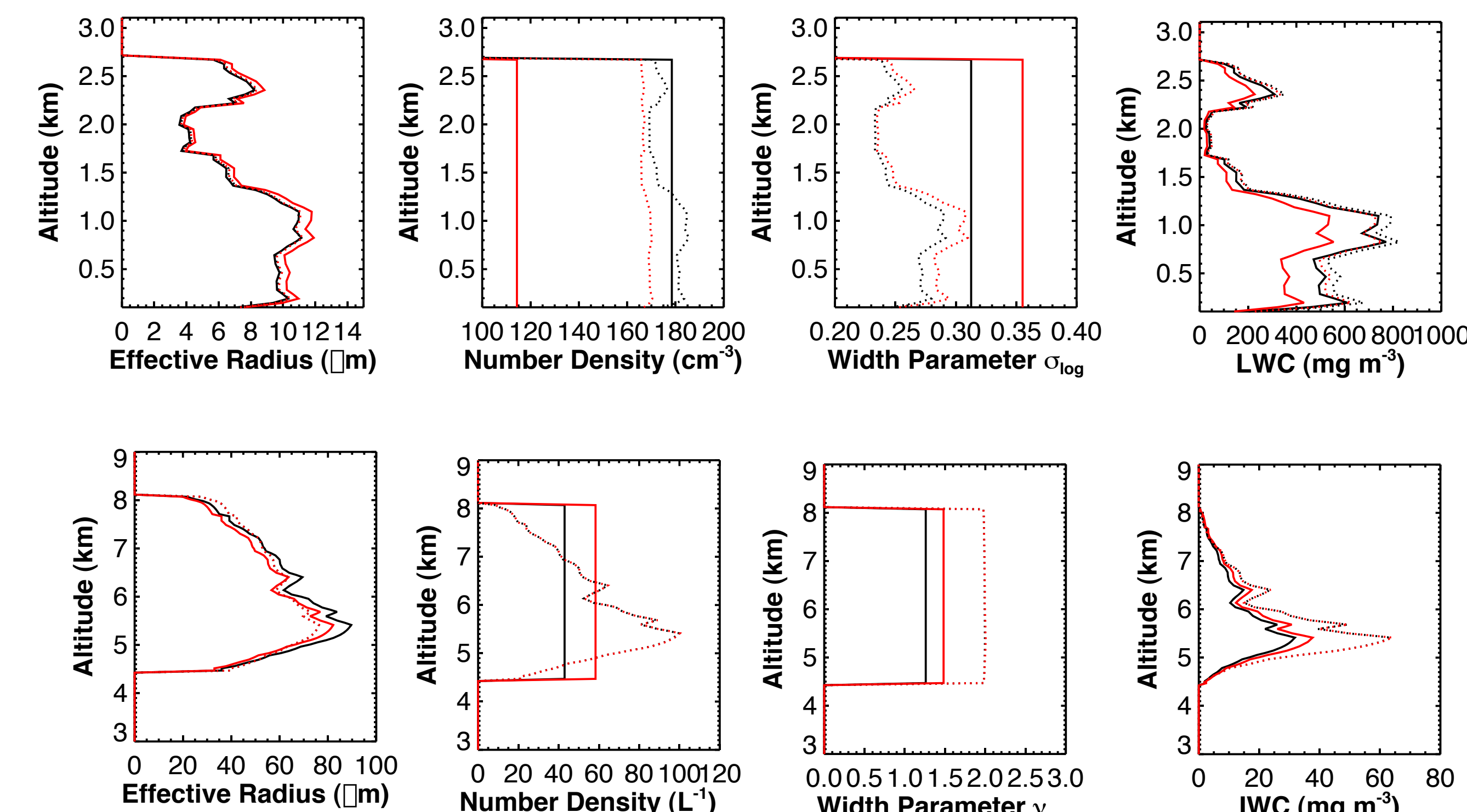

The above plots show sample effects of allowing all parameters to vary for liquid (top row) and ice (bottom row) retrievals with radar-only (RO) and **radar-visible optical depth (RVOD)** solutions.

4. Flux Comparison

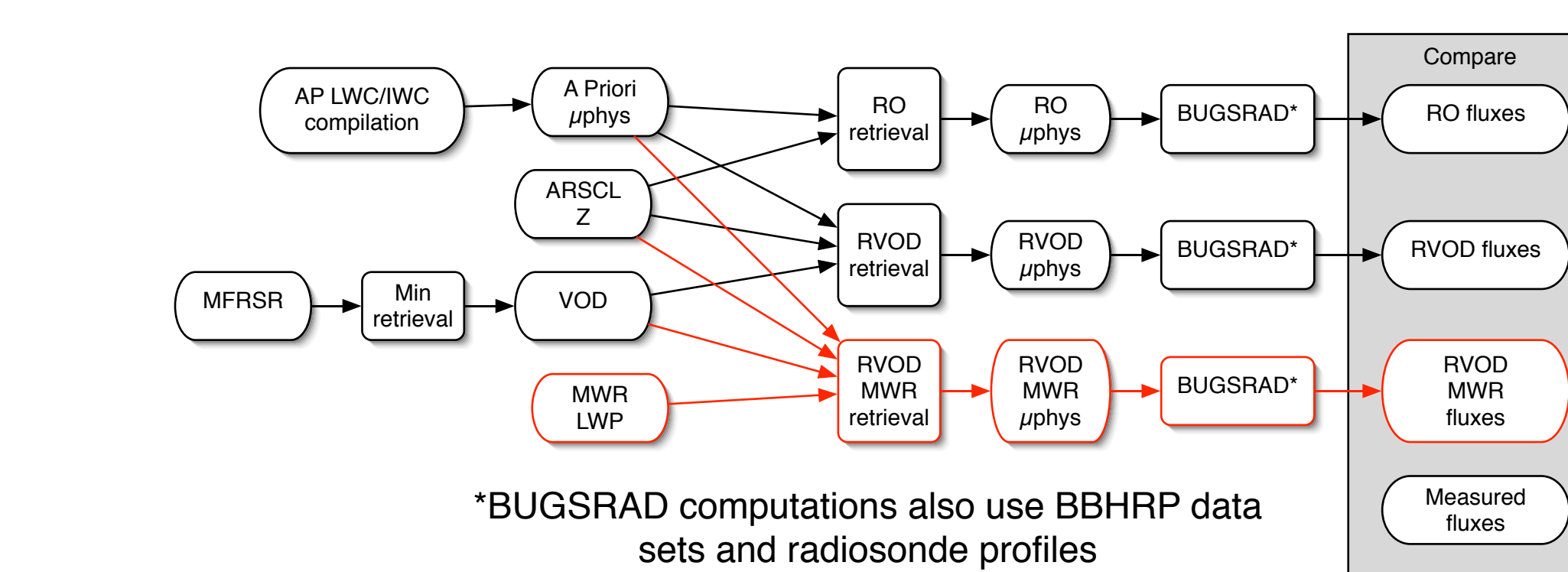

*BUGSRAD computations also use BBHRP data sets and radiosonde profiles

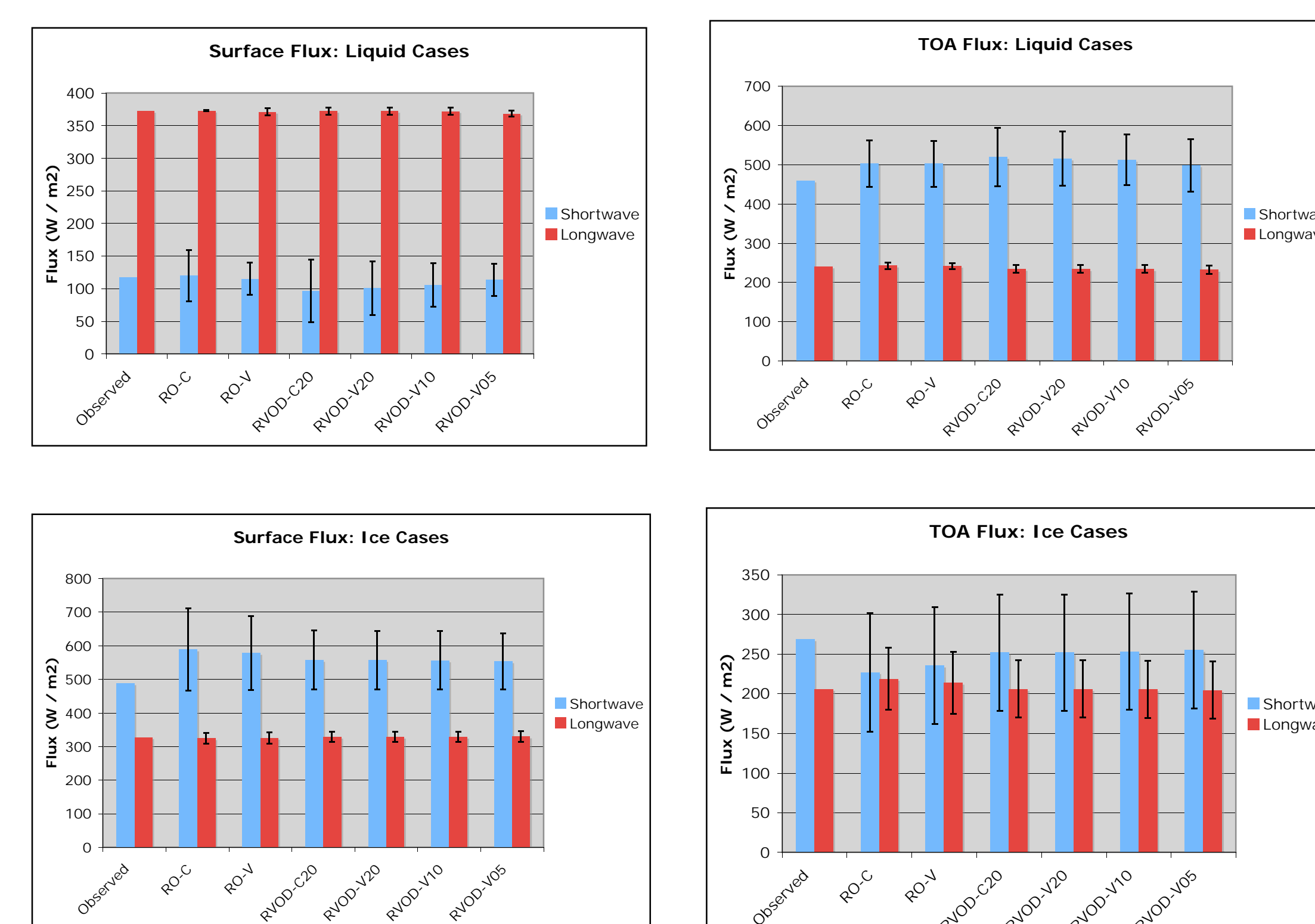

Retrieved cloud properties were used as inputs to a radiative transfer model (BUGSRAD) to calculate fluxes for comparison against observations. Results varied with method, a priori data, and assigned uncertainties.

Summary

A new retrieval scheme allowing all distribution parameters to vary through the cloud column will allow more sophisticated retrievals with better performance.

5. Add MWR data

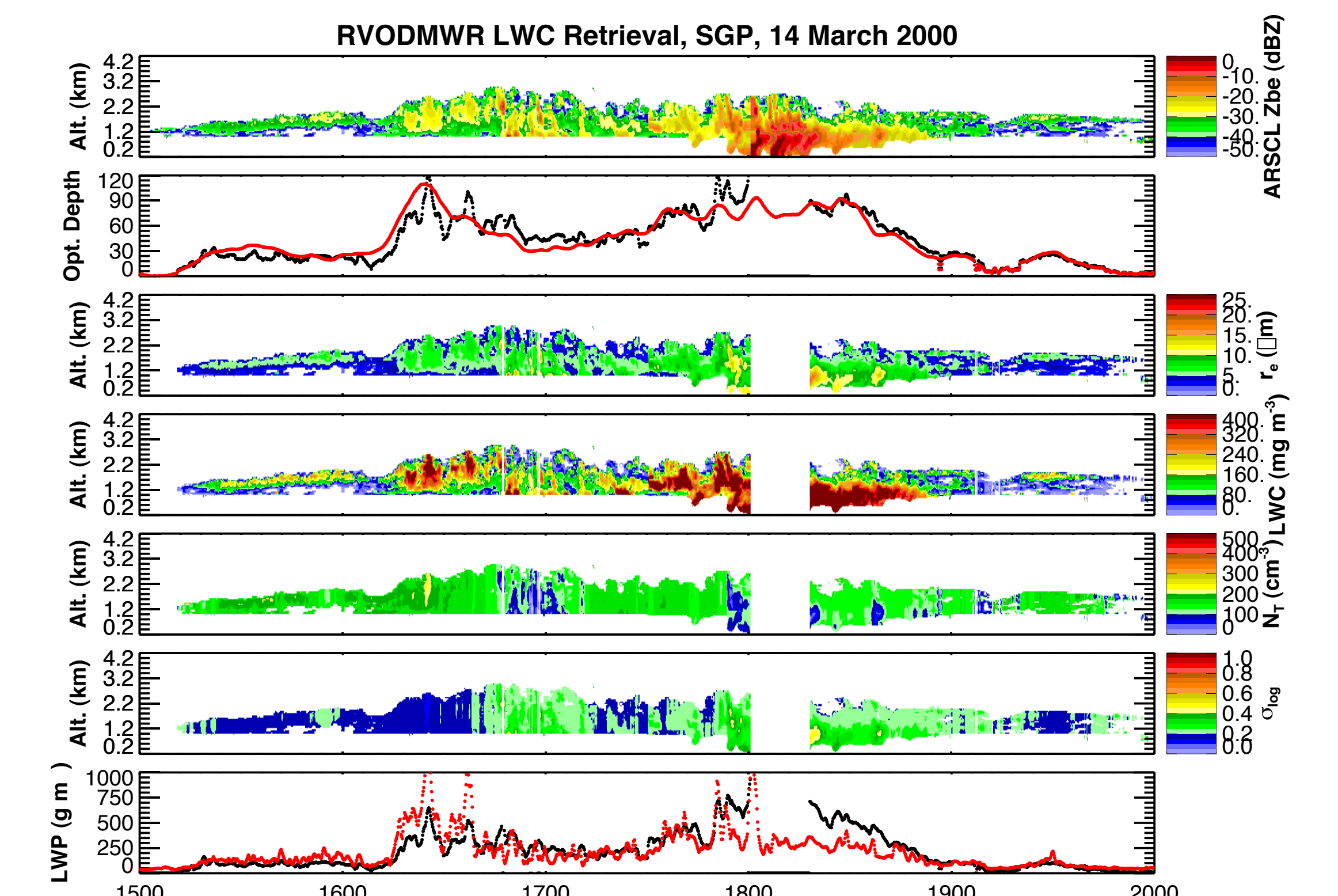

A sample three-instrument retrieval using MMCR, visible optical depth (MFRSR), and liquid water path (MWR), with input measurements in red. The new scheme gives more freedom to fit multiple measurements.

Acknowledgements

The work described here was supported by the Office of Science (BER), U. S. Dept. of Energy, Grant DE-FG02-05ER63961. We also thank Qilong Min and the BBHRP VAP team for providing data used in our analyses.

References

- Austin, R. T., and G. L. Stephens, 2001: J. Geophys. Res., 106, 28233-28242.
- Benedetti, A., G. L. Stephens, and J. M. Haynes, 2003: J. Geophys. Res., 108, 4335, doi:10.1029/2002JD002693.
- Min, Q.-L., M. Duan, and R. Marchand, 2003: J. Geophys. Res., 108, 4547, doi:10.1029/2003JD003385.
- Stephens, G. L., P. M. Gabriel, and P. T. Partain, 2001: J. Atmos. Sci., 58, 3391-3409.